

# HAFCO METALMASTER



**45 Litre Solvent Capacity**



**76 Litre Tank Capacity**

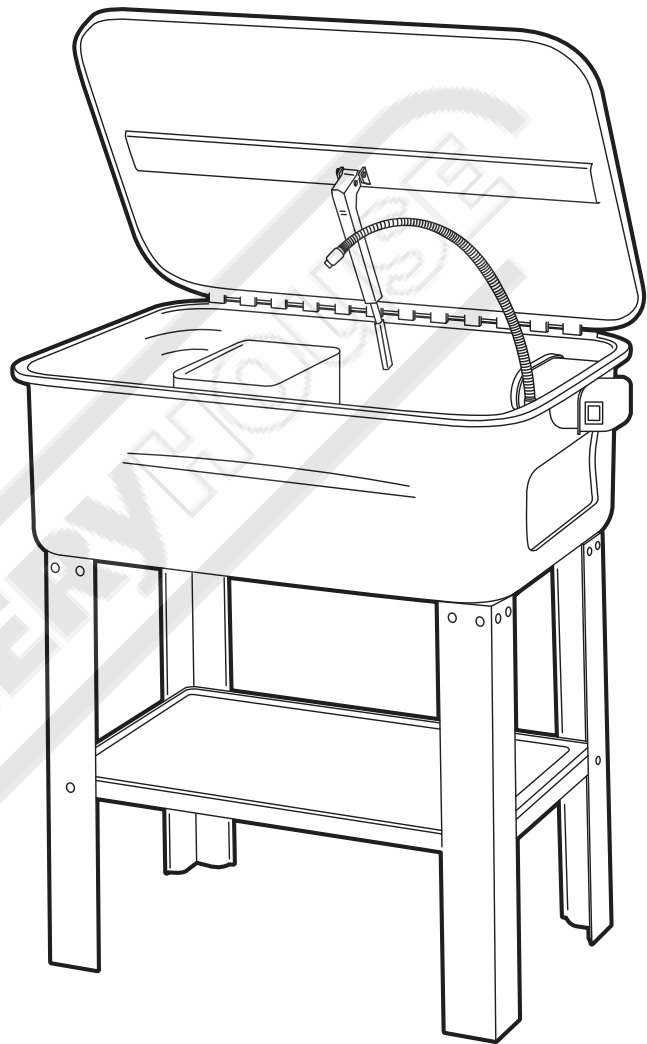

Edition : 1.0  
Date: (06/24)

## Instruction Manual

# AUTO PARTS WASHER APW-76

Order Code: (A368)

## TABLE OF CONTENTS

---

TABLE OF CONTENTS .....	2
SAFETY INFORMATION .....	2
SPECIFICATION .....	3
ELECTRICAL CONNECTIONS .....	4
ASSEMBLY .....	4-5
OPERATION .....	6
ENVIRONMENTAL PROTECTION .....	6
PARTS DIAGRAM .....	7

## GUARANTEE

This product is guaranteed against faulty manufacture for a period of 12 months from the date of purchase. Please keep your receipt as proof of purchase. This guarantee is invalid if the product is found to have been abused or tampered with in any way, or not used for its intended purpose. Faulty goods should be returned to their place of purchase, no product can be returned to us without prior permission.

This guarantee does not effect your statutory rights.

## SAFETY PRECAUTIONS

---

### **WARNING**

**AS WITH ALL MACHINERY, THERE ARE CERTAIN HAZARDS INVOLVED WITH THEIR OPERATION AND USE. EXERCISING RESPECT AND CAUTION WILL CONSIDERABLY LESSEN THE RISK OF PERSONAL INJURY.**

**HOWEVER, IF NORMAL SAFETY PRECAUTIONS ARE OVERLOOKED OR IGNORED, PERSONAL INJURY TO THE OPERATOR OR DAMAGE TO PROPERTY, MAY RESULT.**

1. ALWAYS Learn the machine's applications, limitations, and the specific potential hazards peculiar to it. Read and become familiar with the entire operating manual.
2. ALWAYS wear suitable protective clothing, gloves and goggles.
3. ALWAYS clean off any accidental splashes of degreaser on the skin, seek medical attention immediately if necessary.
4. ALWAYS follow degreaser manufacturer's instructions carefully.
5. ALWAYS check for damage. Before using the washer, any damaged part, should be checked to ensure that it will operate properly, and perform its intended function. Any damage should be properly repaired or the part replaced. If in doubt, DO NOT use the machine.
6. ALWAYS disconnect the washer from the power supply before carrying out any maintenance or cleaning of the parts washer.
7. ALWAYS keep work area clean. Cluttered areas and benches invite accidents, mop up accidental spillages of degreaser immediately.  
ALWAYS ensure that adequate lighting is available. A minimum intensity of 300 lux should be provided. Ensure that lighting is placed so that you will not be working in your own shadow.

## SAFETY PRECAUTIONS

8. ALWAYS keep children away. All visitors should be kept a safe distance from the work area, especially whilst operating the machine.
9. ALWAYS maintain machine in top condition. Keep washer clean for the best and safest performance. Follow maintenance instructions.
10. ALWAYS ensure the switch is off before plugging in to mains. Avoid accidental starting. ALWAYS concentrate on the job in hand, no matter how trivial it may seem. Be aware that
11. accidents are caused by carelessness due to familiarity.
12. ALWAYS keep your proper footing and balance at all times don't over reach. For best footing, wear rubber soled footwear. keep floor clear.

## FEATURES

- **Extra large tank with component shelf, plus small parts tray.**
- **Accepts all common degreasing fluids.**
- **Fusible link automatically closes lid in case of fire.**
- **Built in replacement filter.**
- **Easy maintenance solvent pump.**

## SPECIFICATIONS

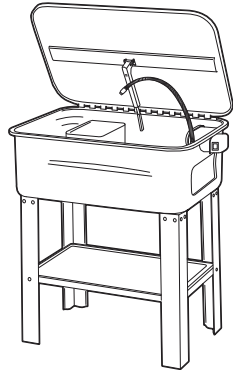
<b>Item Name</b>	
Tank capacity: 76 Litre	
Solvent capacity: 45 Litre	
Max. pump output: 2.7-3.3 L/min	
Electrical Requirement: 120V, 60Hz / 240V, 50Hz	

## ELECTRICAL CONNECTIONS

### **⚠ WARNING**

**WARNING!** Read these electrical safety instructions thoroughly before connecting the product to the mains supply.

Before switching the product on, make sure that the voltage of your electricity supply is the same as that indicated on the rating plate. Connecting it to any other power source may cause damage.

This product may be fitted with a non-rewireable plug. If it is necessary to change the fuse in the plug, the fuse cover must be refitted. If the fuse cover becomes lost or damaged, the plug must not be used until a suitable replacement is obtained.

If the plug has to be changed because it is not suitable for your socket, or due to damage, it should be cut off and a replacement fitted, following the wiring instructions shown below. The old plug must be disposed of safely, as insertion into a mains socket could cause an electrical hazard.

## ASSEMBLY

1. With spring loaded lid closed, place Tub unit upside down on a non-scratching surface (cardboard, carpet etc.).

2. Attach each of the 4 legs with 4 sets each of 6mm screws, lockwashers and nuts to the brackets on the Tub unit (Fig 1).

3. Attach Storage Tray to holes located mid-way of 4 legs with 2 sets each of 6mm screws, lockwashers and nuts (Fig 2).

4. Return the Tub unit to the upright position on its legs and open the springtensioned lid.

5. Thread the fitting of the Flexible Metal "Gooseneck" fluid outlet tube onto the Pump outlet (Fig 3). Place the Pump Box Lid over the open Pump Box with fluid intake perforations and raised ribs downward and over pump. Snap into place (Fig 3).

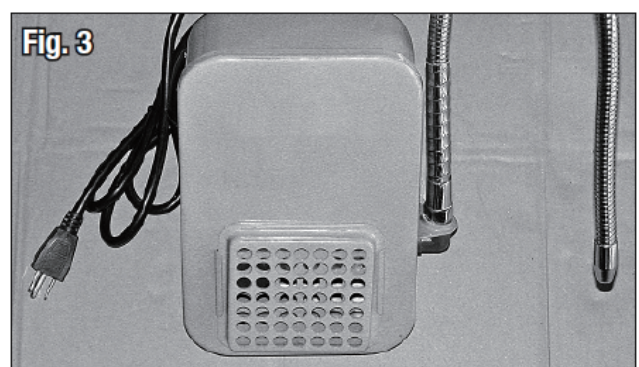
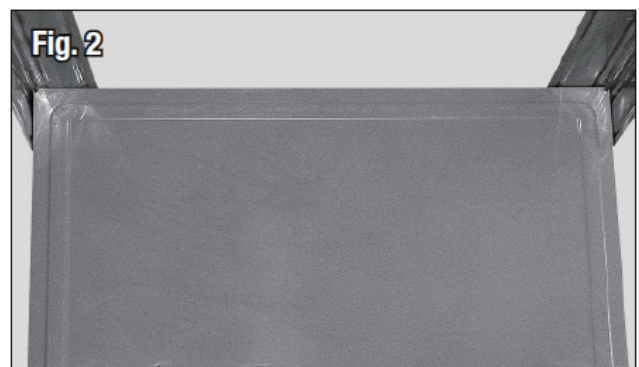
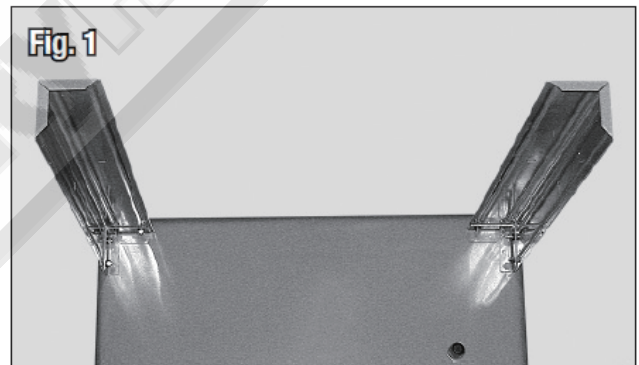

## ASSEMBLY

6. Route the power cord of the Pump Box Assembly through the rectangular opening on the side of the Tub Unit with the Inlet Filter downward and facing inward.

The Power Switch is visible through the rectangular opening. Hook the raised offset tab on the rear of the Pump Box Assembly over the bottom edge of the rectangular opening (Figs 4-5).

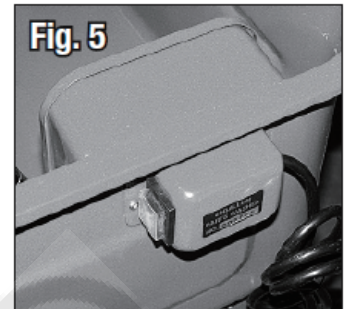
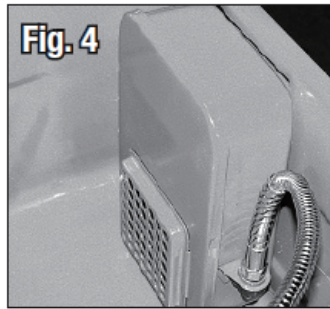

7. Check to see that the Tub drain plug is tightly installed.

8. Place the Parts Cleaning Tray over the edges on the walls of the tub (Fig 6).

9. Make sure the Nozzle of the Flexible Metal "Gooseneck" Fluid Outlet Tube is facing in toward the center of the Tub and downward.

10. The installation of the included Flow-through Parts Cleaning Brush and hose extension is optional. The molded fitting on the hose end opposite the brush may be slipped into place over the Fluid Outlet Tube Nozzle.

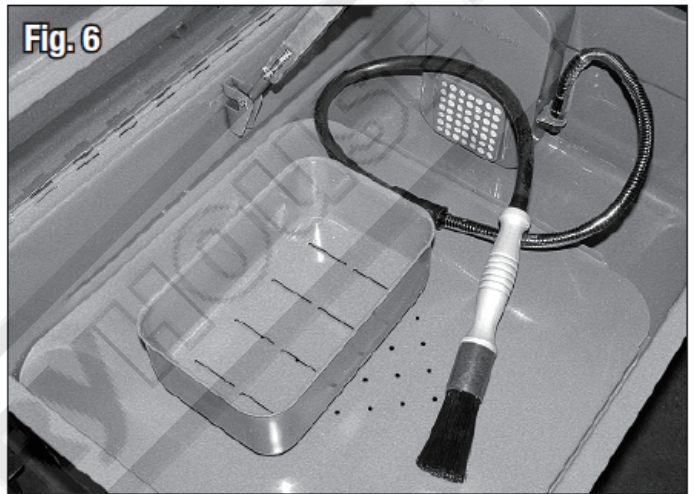

**NOTE: Brush & Rubber Hose are OPTIONAL parts only.**

11. Be sure the Nozzle or Brush outlet is facing in toward the center of the Tub and downward.

12. Fill unit with suitable, water-based degreasing solution sufficiently to cover the entire Inlet Filter (approx. 12 gallons). Important Note: Follow degreasing solution mixing, usage and safety label instructions carefully before using.

13. Plug power cord into an approved, grounded and GFI equipped Outlet.

14. Turn Power Switch to the "On" position. The Parts Washer is now ready for use.

## OPERATION

---

1. Fill only with a non-flammable degreaser or cleaning agent, to just below the level of the parts shelf. DO NOT fill with flammable solvents such as paraffin, thinners, etc.
2. Open the lid, switch the pump on and hold the part to be cleaned under the nozzle, slowly rotate the component until clean.
3. When clean, leave to drain on the tray or in a small component container until dry.
4. Switch off the pump and close the lid and disconnect the power supply.
5. Remove gloves and goggles, store safely.

**Note: Any spillages should be mopped up immediately, so as not to cause a safety hazard.**  
**IMPORTANT:**



1. The Lid Stay incorporates a safety device in the form of a fusible link, which closes the lid in the event of fire. The link is non-resetting and must be replaced should it be activated.
2. Clean the pump filter regularly, by sliding it away from the pump housing and rinsing it in clean degreaser.
3. Do not allow the level of liquid in the parts washer to fall below the pump inlet, as damage to the pump can result.

## ENVIRONMENTAL PROTECTION

---

Do not dispose of this product or damaged components with general household waste. All tools, accessories and packaging should be sorted, taken to a recycling centre and disposed of appropriately.

One of the most damaging sources of environmental pollution is oil products. Never throw away used oil with domestic refuse or flush it down a sink or drain. Collect any oil in a leak proof container and take it to your local waste disposal site.

 Through purchase of this product, the customer is taking on the obligation to the treatment, recycling & recovery and environmentally sound disposal. In effect, this means that this product  must not be disposed of with general household waste. It must be disposed at a recognised disposal facility.

## APPROVED CLEANING SOLUTIONS

---

- ✓ WATER
- ✓ WATER / HOUSEHOLD DETURGENTS (PH6-B)
- ✓ KEROSENE
- ✓ DIESEL FUEL



**“DO NOT USE - PETROL”**

**NOTE: DO NOT OVERFILL - Max. liquid level is just below tray level.**

**THE PUMP WILL BE DAMAGED IF SOLUTIONS OTHER THAN THE ABOVE ARE USED AND WARRANTY WILL BE VOID**

# PARTS DIAGRAM

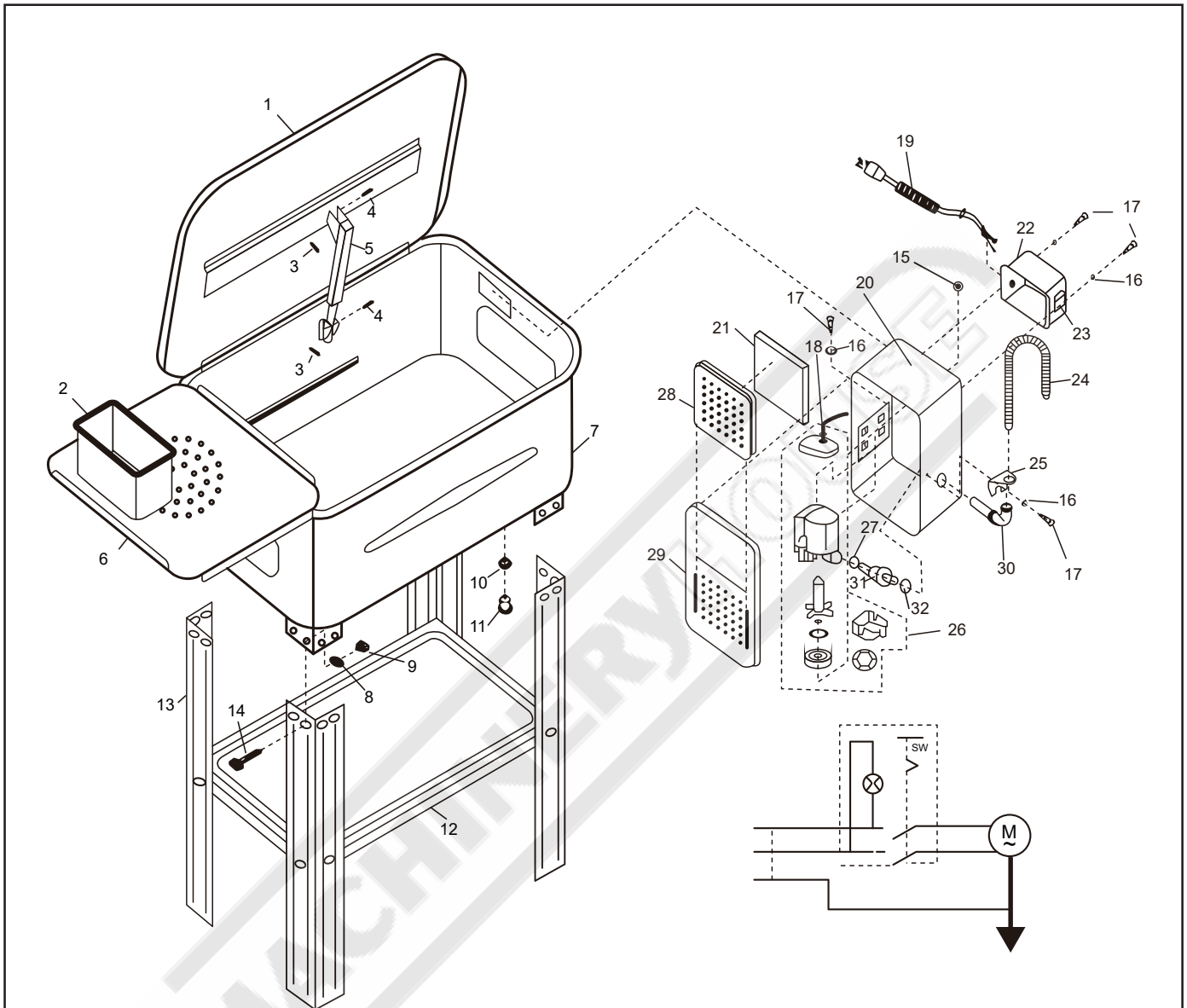

## PARTS LIST

N.O.	DESCRIPTION	N.O.	DESCRIPTION	N.O.	DESCRIPTION
1	Lid	12	Storage Tray	23	On/Off Switch
2	Small Parts Container	13	Leg	24	Flexible Metal Tube
3	Spring Pin	14	Pan Head Screw	25	Elbow Seat
4	Pin	15	Nut	26	Pump Assy complete
5	Lid Stay c/w Fusible Link	16	Spring Washer	27	Shin Washer
6	Parts Cleaning Tray	17	Screw	28	Filter Cover
7	Tub	18	Grommet	29	Pump Housing Cover
8	Spring Washer	19	Power Cable & Plug	30	Elbow
9	Nut	20	Pump Housing	31	Spilgot
10	'O'-Ring	21	Filter	32	Plastic washer
11	Plug	22	Switch Box		

# WARNING

## General Machinery Safety Instructions

---

Machinery House  
requires you to read this entire Manual before using this machine.

- 1. Read the entire Manual before starting machinery.** Machinery may cause serious injury if not correctly used.
- 2. Always use correct hearing protection when operating machinery.** Machinery noise may cause permanent hearing damage.
- 3. Machinery must never be used when tired, or under the influence of drugs or alcohol.** When running machinery you must be alert at all times.
- 4. Wear correct Clothing.** At all times remove all loose clothing, necklaces, rings, jewelry, etc. Long hair must be contained in a hair net. Non-slip protective footwear must be worn.
- 5. Always wear correct respirators around fumes or dust when operating machinery.** Machinery fumes & dust can cause serious respiratory illness. Dust extractors must be used where applicable.
- 6. Always wear correct safety glasses.** When machining you must use the correct eye protection to prevent injuring your eyes.
- 7. Keep work clean and make sure you have good lighting.** Cluttered and dark shadows may cause accidents.
- 8. Personnel must be properly trained or well supervised when operating machinery.** Make sure you have clear and safe understanding of the machine you are operating.
- 9. Keep children and visitors away.** Make sure children and visitors are at a safe distance for you work area.
- 10. Keep your workshop childproof.** Use padlocks, Turn off master power switches and remove start switch keys.
- 11. Never leave machine unattended.** Turn power off and wait till machine has come to a complete stop before leaving the machine unattended.
- 12. Make a safe working environment.** Do not use machine in a damp, wet area, or where flammable or noxious fumes may exist.
- 13. Disconnect main power before service machine.** Make sure power switch is in the off position before re-connecting.
- 14. Use correct amperage extension cords.** Undersized extension cords overheat and lose power. Replace extension cords if they become damaged.
- 15. Keep machine well maintained.** Keep blades sharp and clean for best and safest performance. Follow instructions when lubricating and changing accessories.
- 16. Keep machine well guarded.** Make sure guards on machine are in place and are all working correctly.
- 17. Do not overreach.** Keep proper footing and balance at all times.
- 18. Secure workpiece.** Use clamps or a vice to hold the workpiece where practical. Keeping the workpiece secure will free up your hand to operate the machine and will protect hand from injury.
- 19. Check machine over before operating.** Check machine for damaged parts, loose bolts, Keys and wrenches left on machine and any other conditions that may effect the machines operation. Repair and replace damaged parts.
- 20. Use recommended accessories.** Refer to instruction manual or ask correct service officer when using accessories. The use of improper accessories may cause the risk of injury.
- 21. Do not force machinery.** Work at the speed and capacity at which the machine or accessory was designed.
- 22. Use correct lifting practice.** Always use the correct lifting methods when using machinery. Incorrect lifting methods can cause serious injury.
- 23. Lock mobile bases.** Make sure any mobile bases are locked before using machine.
- 24. Allergic reactions.** Certain metal shavings and cutting fluids may cause an allergic reaction in people and animals, especially when cutting as the fumes can be inhaled. Make sure you know what type of metal and cutting fluid you will be exposed to and how to avoid contamination.
- 25. Call for help.** If at any time you experience difficulties, stop the machine and call you nearest branch service department for help.



# WARNING

## Parts Washer Safety Instructions

---

Machinery House  
requires you to read this entire Manual before using this machine.

- 1. Maintenance.** Make sure the Parts Washer is turned off and disconnect from the main power supply before any inspection, adjustment or maintenance is carried out. The Parts Washers tub and filters should be cleaned on a regular basis to keep the pump free from being blocked. Replace nozzles, hoses & pump when become worn. Check the cabinet for any leaks.
- 2. Leaving a Parts Washer Unattended.** Always turn the Parts Washer off before leaving the Parts Washer. Do not leave Parts Washer running unattended for any reason.
- 3. Protecting environment.** Keep Part Washer lid shut when not in use.
- 4. Understand the machines controls.** Make sure you understand the use and operation of all controls.
- 5. Power outage.** In the event of a power failure during use of the machine, turn off all switches to avoid possible sudden start up once power is restored.
- 6. Fire Hazard.** Do not use flammable solvents such as petrol. Refer to manual for appropriate solvents.
- 7. Eye protection.** Always wear safety glasses when using and cleaning this machine.
- 8. Hand protection.** It is recommended to wear correct safety gloves when using and cleaning this machine.
- 9. Fume hazard.** Parts Washer cleaning solvents can give off hazardous fumes, which may cause long term respiratory problems if inhaled. Always have good ventilation and use a breathing respirator if applicable.
- 10. Other Hazards.** Do not allow children anywhere near this machine. Serious injury can occur.
- 11. Call for help.** If at any time you experience difficulties, stop the machine and call you nearest branch service department for help.

# PLANT SAFETY PROGRAM

## **NEW MACHINERY HAZARD IDENTIFICATION, ASSESSMENT & CONTROL**

### **Parts Washer**

Developed in Co-operation Between A.W.I.S.A and Australia Chamber of Manufactures  
 This program is based upon the Safe Work Australia, Code of Practice - Managing Risks of Plant in the Workplace ( WHSA 2011 No10 )

Item No.	Hazard Identification	Hazard Assessment	Risk Control Strategies <small>(Recommended for Purchase / Buyer / User)</small>
H	ELECTRICAL	MEDIUM	All electrical enclosures should only be opened with a tool that is not to be kept with the machine.  (Recommended for Purchase / Buyer / User)
M	HIGH TEMPERATURE or FIRE	MEDIUM	Keep electrical equipment away from parts washer.  Ensure correct solvent is used. To reduce the risk of fire, do not operate parts washer in the vicinity of open flames
O	OTHER HAZARDS, CHEMICALS, FUMES.	LOW	Wear safety glasses. Wear protective gloves. Use parts washer in a well ventilated area.



Plant Safety Program to be read in conjunction with manufactures instructions



[www.machineryhouse.com.au](http://www.machineryhouse.com.au)



[www.machineryhouse.co.nz](http://www.machineryhouse.co.nz)

Authorised and signed by:  
 Safety officer:   
 Manager: 

Revised Date: 12th March 2012

The following section covers the spare parts diagrams and lists that were current at the time this manual was originally printed. Due to continuous improvements of the machine, changes may be made at anytime without notification.

## HOW TO ORDER SPARE PARTS

1. Have your machines model number, serial number & date of manufacture on hand, these can be found on the specification plate mounted on the machine
2. A scanned copy of your parts list/diagram with required spare part/s identified.

### **NOTE: SOME PARTS MAY ONLY BE AVAILABLE AS AN ASSEMBLY**

3. Go to [www.machineryhouse.com.au/contactus](http://www.machineryhouse.com.au/contactus) and fill out the inquiry form attaching a copy of scanned parts list.



### **WARNING!**

*Electricity is dangerous and could cause death  
All electrical work must be carried out by a qualified electrician.*



### **CAUTION**

*It is impossible to cover all possible hazards Every workshop environment is different. These are designed as a guide to be used to compliment training and as a reminder to users prior to equipment use. Always consider safety first, as it applies to the individual working conditions.*



### ENVIRONMENT PROTECTION

Recycle unwanted materials instead of disposing of them as waste. All tools, accessories and packaging should be sorted, taken to a recycling centre and disposed of in a manner which is compatible with the environment. When the product becomes completely unserviceable and requires disposal, drain any fluids (if applicable) into approved containers and dispose of the product and fluids according to local regulations.

Imported by

**HARE & FORBES**  
**MACHINERYHOUSE**

Australian Distributor

**Hare & Forbes**  
**Machineryhouse**  
Sydney - Melbourne  
Adelaide - Brisbane - Perth

Ph: 1300 202 200  
[www.machineryhouse.com.au](http://www.machineryhouse.com.au)

**MACHINERYHOUSE**

New Zealand Distributor

**Machineryhouse**  
Auckland  
Christchurch

Ph: 0800 142 326  
[www.machineryhouse.co.nz](http://www.machineryhouse.co.nz)